

Opal Bathroom Accessories

Versions:202311

Finish



Brushed Bronze



Graphite



Brushed Gold



Brushed Nickel

Opal Bathroom Accessories

OPAL ROBE HOOK
NR2582BN / NR2582GR / NR2582BG
NR2582BZ

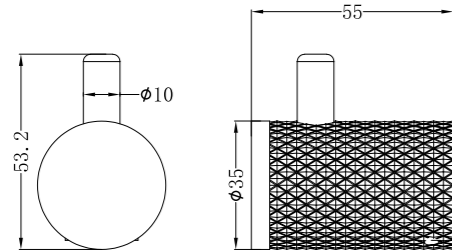

OPAL TOWEL RING
NR2580aBN / NR2580aGR / NR2580aBG
NR2580aBZ

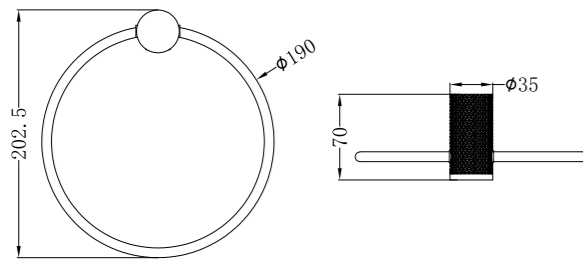

OPAL TOILET ROLL HOLDER
NR2586BN / NR2586GR / NR2586BG
NR2586BZ

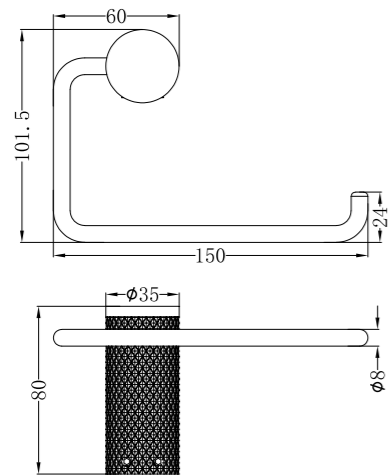

OPAL METAL SHOWER SHELF
NR2587aBN / NR2587aGR / NR2587aBG
NR2587aBZ

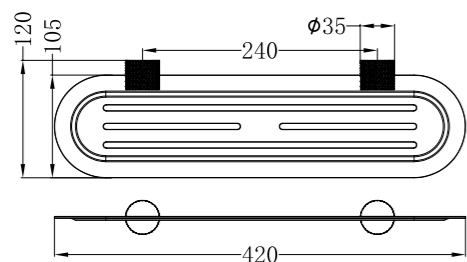

OPAL DOUBLE TOWEL RAIL 600MM
NR2524dBN / NR2524dGR / NR2524dBG
NR2524dBZ

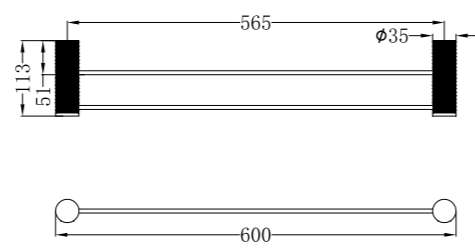

OPAL SINGLE TOWEL RAIL 600MM
NR2524BN / NR2524GR / NR2524BG
NR2524BZ

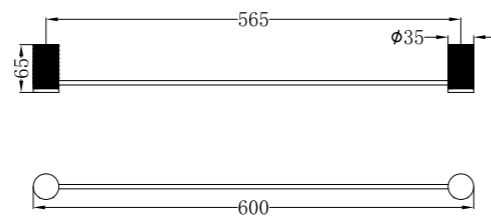

OPAL DOUBLE TOWEL RAIL 800MM
NR2530dBN / NR2530dGR / NR2530dBG
NR2530dBZ

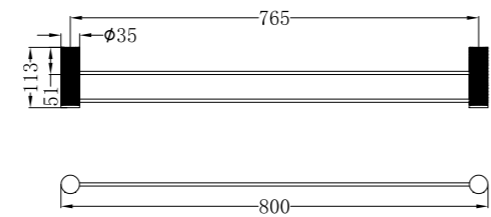

OPAL SINGLE TOWEL RAIL 800MM
NR2530BN / NR2530GR / NR2530BG
NR2530BZ

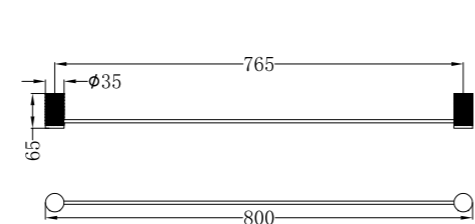

OPAL SOAP DISH HOLDER
NR2581BN / NR2581GR / NR2581BG
NR2581BZ

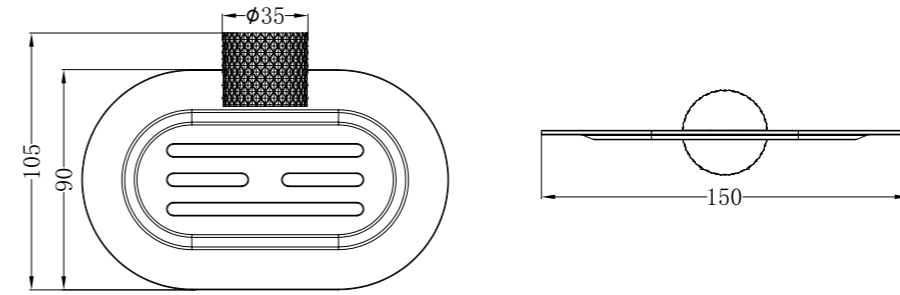

Installation Instruction

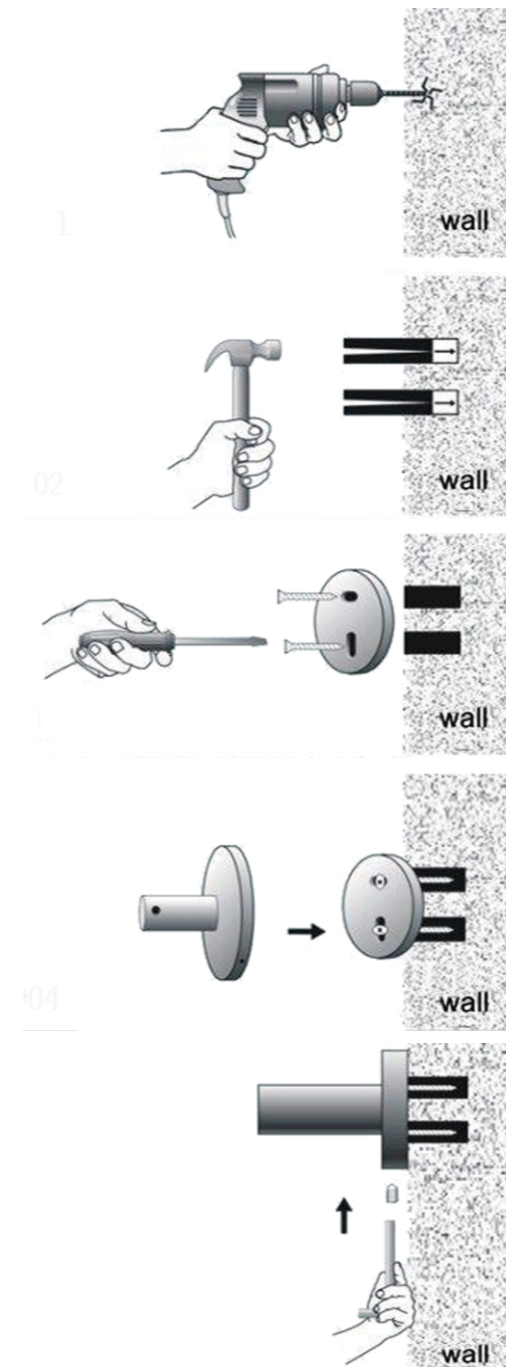

1. Put the fixing blocks (piece) over on the right place on the wall, and stay level, use marking pen through the holes of fixing block to mark out fixing spots on the wall. Then drill holes by electric hand drill with 6mm drilling bit on the spots.

2. Put the expansion plugs into the wall by hammer.

3. Put fixing block cover on the holes and fix firmly by expansion screws.

4. Put the base of bathroom accessory cover on the fixing blocks.

5. Screw grub screws into the base, make it against to the fixing block tight and firm.

Nero

info@nerotapware.com.au
nerotapware.com.au

11-13 Buontempo Road
Carrum Downs Vic 3201

